

700 SERIES HARVESTER

NEXT LEVEL HARVESTING

Designed with today's higher-level harvesting capacities in mind, the new 700 series harvesters can handle more volume and offer improved cleaning. Save time and money with LOCKWOOD®'s efficient 774 Harvester.







New 10" touch screen control system with joystick control.







Wider rear cross and side elevator for increased volume.



700 SERIES HARVESTER

-  New 10" touch screen control system with joystick control.
-  Wider rear cross and side elevator for increased volume.
-  Higher capacity full swing boom for truck loading efficiency.
-  Numerous side elevator and full width cleaning table options.
-  Dual LOCKWOOD® high-efficiency fans for increased air flow using less power.

-  Improved cleaning.
-  OPTIONAL wheel drive.
-  OPTIONAL vine chopper.
-  Industry leading visibility for the operator.



*Primary hump
in the nose.*

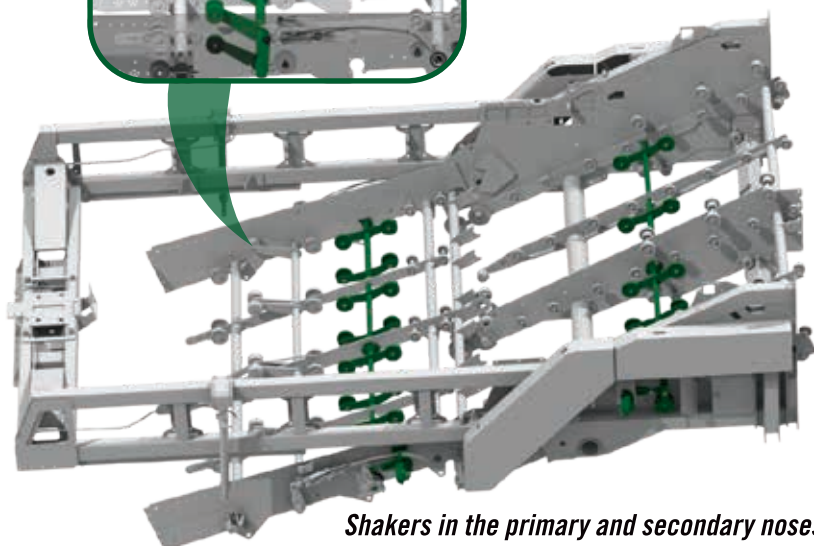

Shakers in the primary and secondary noses.

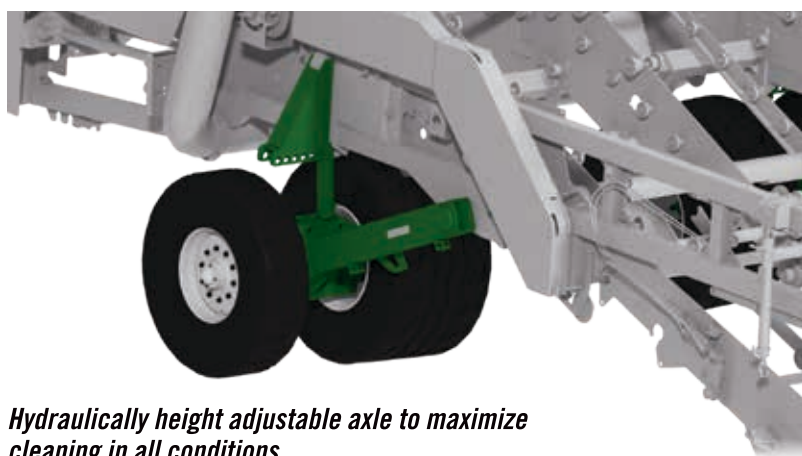

*Hydraulically height adjustable axle to maximize
cleaning in all conditions.*

MODEL	774 HARVESTER
NUMBER OF ROWS	4
ROW SPACING	32" – 38"
DIGGING SPEED	2 – 5 mph
HEADLAND REQUIRED	24'
WIDE DIGGER NOSE WIDTH	142"
NARROW DIGGER NOSE WIDTH	136"
TRACTOR PTO HP (MIN)	250 HP
BASE MACHINE (LBS)	35,000 – 42,000